

# ERGOX

CENTRAL VACUUM SYSTEMS FOR INDUSTRY AND CAR WASH



PRODUCT CATALOGUE

# Car Wash





**ERGOX** 





## A NEW GENERATION OF CENTRAL VACUUM SYSTEMS

ERGOX is specialized in professional central vacuum systems. Established in Belgium, now it's already known in many countries around the world for its high-efficient, maintenance free, energy-saving and environmentally friendly vacuum systems. Our team provides standard or tailor-made systems, answering all the customer's needs. The company operates on the principle of providing high quality personal service, support and advice throughout the construction process and continuing after the project is ready.





### FLEXIBILITY OF OWN PRODUCTION SITE

Nowadays Ergox is successful producing company equipped with a modern machinery park: from CNC cutting, sheet rolling, pipe/profile rolling, turning, welding and stamping to a lab where complex control systems are born and where new products see life.

This provides even more flexibility in the custom-made solutions, shorter delivery terms, better quality control and allows us to provide the A-Z solutions for projects, without any interference of the 3rd companies.







## CONTENTS

CONTROL BOARDS	8
VACUUM PRODUCERS	9
FILTER SYSTEMS	12
PIPE SUPPORTS & PILLARS	18
VACUUM VALVES	27
TOOL HOLDERS	28
PAYMENT SYSTEMS	30
PIPING	36
PNEUMATIC FITTINGS & HOSE	44
PE HOSE & COMPRESSION FITTINGS	48
CLEANING TOOLS & ACCESSOIRES	50
CAR WASH EXTRA'S	53
SPARE PARTS & COMPLEMENTARY ITEMS	58
NOTES	59

# CONTROL BOARDS



Control board with full energy management system, complete with invertors on each motor, programmable logic controller, 8" touchscreen, pressure sensors, filter control system and automatic maintenance system. Fully prepared to connect easily to vacuum producers, to ERGOX tool holders and to single or centralised payment systems. It is quick to install, as everything is pre-mounted. Simple connection of the cables at the bottom of the board and going through the setup menu is enough to get the system ready to go.

Required power supply: 3x400V+N+PE / Required air pressure supply: 6bar



ART.NO.**	Power, kW / Amperage, A	Q-ty of connected motors	Max. simultaneous users* (= standard foreseen q-ty of vacuum hoses (in/outs))	Dimensions hxxwxd (mm)
CAR015	15 / 32	1	7	1400x1000x300
CAR030	30 / 63	2	14	2000x1200x400
CAR045	45 / 100	3	21	2000x1200x400
CAR060	60 / 125	4	28	2000x1200x400
CAR075	75 / 160	5	35	2000x1800x400
CAR090	90 / 200	6	42	2000x1800x400
CAR105	105 / 250	7	49	2000x1800x400

\*depends on requested vacuum level (set via touchscreen) and general structure of the system

\*\*standard version foresees FREE use of the system (vacuum hoses and/or additional options are NOT connected to the payment system)



Extra options:

ART. NO.	Description
SOL001	Extra in/out on panel (extra vacuum hose connection)
OPTMOD	Start fee per paid option
SOL002	Air pressure gun connection to payment system (always to combine with OPTMOD)
SOL003	Tire inflation unit connection to payment system (always to combine with OPTMOD)
SOL004	Extra fee for installing solenoids in separate box



## VACUUM PUMP/BLOWER

Maintenance free side channel vacuum producer GD, driven by Siemens induction motor. The best in his category with a lifetime of more then 40,000 working hours.

For an energy friendly carwash vacuum system with the best return/power ratio, the VAP013 is perfect for the job. Several VAP013 can be combined together for getting higher total power.

ART.NO.	Power min, kW	Power @50Hz, kW	Power max, kW	Max. users*	Airflow max, m <sup>3</sup> /h	Weight, kg	Dimensions hxxd, cm
VAP007	1,5	4	6,9	2	675	55	46x40x50
VAP013	1,8	7,5	14	6/7	1150	167	69x58x78
VAP026	11	18,5	26	10/11	1875	247	79x58x85

\*max. simultaneous users when vacuuming with the hose dia 38mm, lenght min 5m with crevice tool attached.



## SILENCER

Body: steel, powder coated / RAL7035

Inside: absorbent foam, polyether with flame protection

ART.NO.	Pipe connection diameter, mm	Outside diameter, mm	Weight, kg	Length, cm
SIL102	102	152	14,5	120
SIL152	152	202	21	120
SIL000*	152	-	235	-

\*ERGOX SUPER SILENCER, more information on request





## MOUNTING FRAME

ART. NO.	Application	Material / color	Weight, kg	Dimensions incl. vacuum producer hxxwxd, cm
FRA002	Metal frame for tower mounting for 2 vacuum producers (to save floor space)	Steel, powder coated / RAL7035	55	150x58x104
FRA003	Metal frame for tower mounting for 3 vacuum producers (to save floor space)	Steel, powder coated / RAL7035	76	220x58x104



## MOUNTING ACCESSOIRES

	ART. NO.	Description	Material / color
	PCV127O	Pipe collector for vacuum producer 127x127x76, open model	Steel, powder coated / RAL7035
	PCV127C	Pipe collector for vacuum producer 127x127x76, closed model	Steel, powder coated / RAL7035
	RED257	Reduction 2,5" x 76mm, length 100mm	Steel, zinc coated
	NRV025	Non return valve dia 76mm x 2,5"	Steel, powder coated / RAL7035
	NRV102	Non return valve dia 102mm x 102mm	Steel, epoxy spray painted in ECL001



**ALSO NECESSARY:** the pipe couplings dia 76mm and 127mm (see page 41)

For connecting in tower of 2:

2xPCV127O+2xPCV127C+2xPCO127+4xPCO076+2xNRV025+2xRED257.







For connecting in tower of 3:

4xPCV127O+2xPCV127C+4xPCO127+6xPCO076+3xNRV025+3xRED257



## VACUUM PUMP SET

Complete pre-assembled set/tower of several VAP013 vacuum producers, incl. mounting accessories, connectors, collectors and frames, excl. silencer.

ART. NO.	Q-ty vacuum pumps VAP013 in set	Configuration	Max. users*	Weight, kg	Dimensions hxxwxd, cm
VAP013S2	2		13-14	409	150x58x104
VAP013S3	3		20-21	607	220x58x104
VAP013S4	4		26-27	818	150x127x104
VAP013S5	5		32-33	1016	220x127x104
VAP013S6	6		38-39	1214	220x127x104
VAP013S7	7		45-46	1425	220x195x104

\*max. simultaneous users when vacuuming with the hose dia 38mm, lenght min 5m with crevice tool attached.

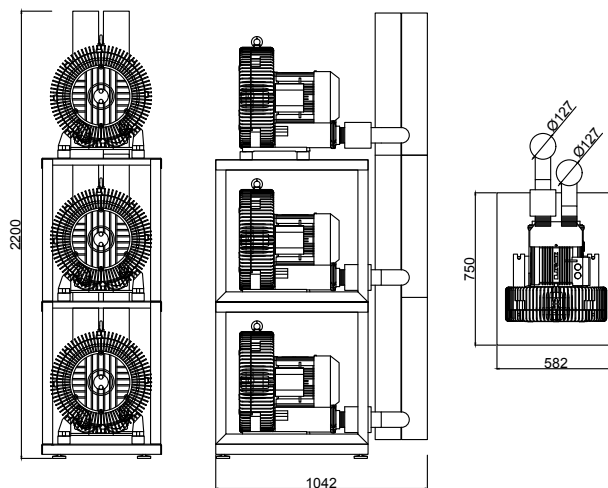

# FILTER SYSTEMS



## FILTER SYSTEM WITH 1 CARTRIDGE FILTER

- ▶ Heavy duty industrial cartridge filter system (with polyester cartridge).
- ▶ Fully automatic cleaning system with reverse pulse jet technology for a maintenance free system.
- ▶ Filter performance is automatically controlled by the main control board.
- ▶ Complete with 80L dust container.

ART. NO.	Filter surface, polyester, m <sup>2</sup>	Dust container capacity, L	Max. airflow, m <sup>3</sup> /h	Max. negative pressure, mbar*	Weight, kg	Dimensions hxxwxd, cm
SEP020	20	80	1000	-250	270	245x75x91,5

**NOTE:** It is necessary to foresee each vacuum system with a SAFETY VALVE (to order separately, see page 56) to protect the filter system in case of too high negative pressure in the system

\*Filter systems with higher negative pressure upon request.

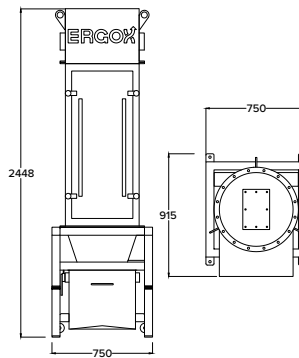

## FILTER SYSTEM WITH 2 CARTRIDGE FILTERS

- ▶ Heavy duty industrial cartridge filter system (with polyester cartridges).
- ▶ Fully automatic cleaning system with reverse pulse jet technology for a maintenance free system.
- ▶ Filter performance is automatically controlled by the main control board.
- ▶ Complete with 80L dust container.

ART. NO.	Filter surface, polyester, m <sup>2</sup>	Dust container capacity, L	Max. airflow, m <sup>3</sup> /h	Max. negative pressure, mbar*	Weight, kg	Dimensions hxxwxd, cm
SEP040	40	80	2000	-250	375	251x90x145

**NOTE:** It is necessary to foresee each vacuum system with a SAFETY VALVE (to order separately, see page 56) to protect the filter system in case of too high negative pressure in the system.

\*Filter systems with higher negative pressure upon request.

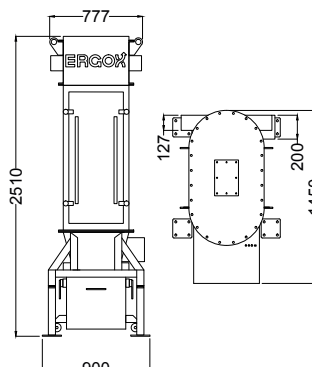



## FILTER SYSTEM WITH 4 CARTRIDGE FILTERS

- ▶ Heavy duty industrial cartridge filter system (with polyester cartridges).
- ▶ Fully automatic cleaning system with reverse pulse jet technology for a maintenance free system.
- ▶ Filter performance is automatically controlled by the main control board.
- ▶ Complete with 80L dust container.

ART. NO.	Filter surface, polyester, m <sup>2</sup>	Dust container capacity, L	Max. airflow, m <sup>3</sup> /h	Max. negative pressure, mbar*	Weight, kg	Dimensions hwxwd, cm
SEP080	80	80	4000	-250	450	268,5x134,5x153

**NOTE:** It is necessary to foresee each vacuum system with a SAFETY VALVE (to order separately, see page 56) to protect the filter system in case of too high negative pressure in the system.

\*Filter systems with higher negative pressure upon request.

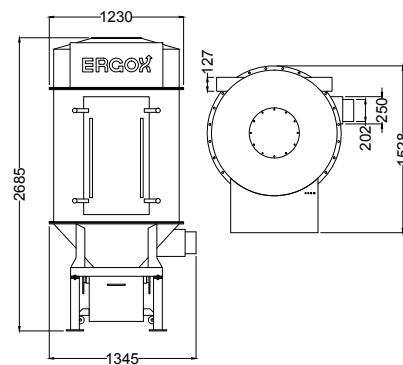



## FILTER SYSTEM WITH 6 CARTRIDGE FILTERS

- ▶ Heavy duty industrial cartridge filter system (with polyester cartridges).
- ▶ Fully automatic cleaning system with reverse pulse jet technology for a maintenance free system.
- ▶ Filter performance is automatically controlled by the main control board.
- ▶ Complete with 80L dust container.

ART. NO.	Filter surface, polyester, m <sup>2</sup>	Dust container capacity, L	Max. airflow, m <sup>3</sup> /h	Max. negative pressure, mbar*	Weight, kg	Dimensions h x w x d, cm
SEP120	120	80	6000	-250	540	268,5x167,5x188

**NOTE:** It is necessary to foresee each vacuum system with a SAFETY VALVE (to order separately, see page 56) to protect the filter system in case of too high negative pressure in the system.

\*Filter systems with higher negative pressure upon request.

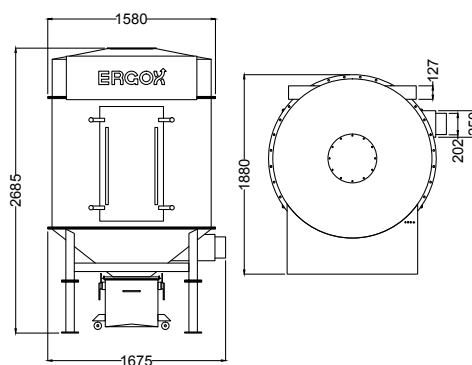



## CYCLONIC PRESEPARATOR

- ▶ Preseparator to use in combination with the ERGOX cartridge filter system.
- ▶ No filter inside, maintenance free.
- ▶ Preseparator will take the workload from the cartridge filter, a combination of both will provide a fully maintenance free system.
- ▶ Preseparator is foreseen from an 80L dustbin, that needs to be emptied once in approx. 2000 cleaned cars. Standard version has 1 inlet (on middle body) and 1 outlet (on head piece).
- ▶ Preseparators are available in powder coated steel (for indoor use only) and in stainless steel (for outdoor and indoor use).

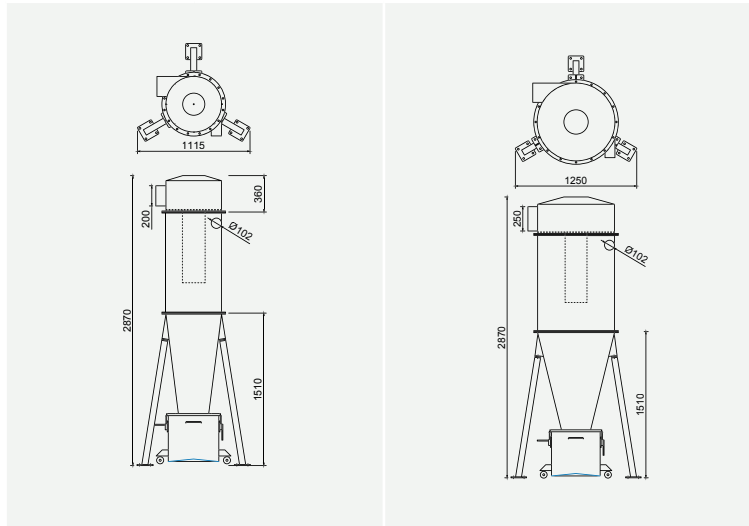

Material	Steel, powder coated in RAL7035*	Stainless steel	Steel, powder coated in RAL 7035*	Stainless steel
ART. NO.	VOW190	VOR190	VOW240	VOR240
Diameter in/out, mm	102/200		102/250	
Dust container capacity, L	80		80	
Max.airflow, m <sup>2</sup> /h	1900		3500	
Weight, kg	185		260	
Dimentions, cm	287x111,5x111,5		287x125x125	



\*Other colors are possible on request.

## Cyclonic Preseparator



### MODIFICATIONS

In some particular cases the following adjustments can be done to the standard version of the preseparator:

ART. NO.	Description
VOW190M	Reduced middle body height for VOW190 (H=50cm instead of 100cm in standaard version)
VOR190M	Reduced middle body height for VOR190 (H=50cm instead of 100cm in standaard version)
VOW240M	Reduced middle body height for VOW240 (H=50cm instead of 100cm in standaard version)
VOR240M	Reduced middle body height for VOR240 (H=50cm instead of 100cm in standaard version)
VOW190H	Head piece outlet on the top instead of on the side, for VOW190
VOR190H	Head piece outlet on the top instead of on the side, for VOR190
VOW240H	Head piece outlet on the top instead of on the side, for VOW240
VOR240H	Head piece outlet on the top instead of on the side, for VOR240

### EXTRA INLET RING

Additional body ring that allows to add an extra inlet to the standard cyclonic preseparator, if necessary. This makes the system easily adjustable to different construction variants.



ART. NO.	Description	Inlet(s) diameter, mm	Ring height, cm	Weight, kg
VOW190R1	Extra ring with 1 inlet for VOW190	102	22,5	17
VOR190R1	Extra ring with 1 inlet for VOR190			17
VOW240R1	Extra ring with 1 inlet for VOW240			24
VOR240R1	Extra ring with 1 inlet for VOR240			24
VOW190R2	Extra ring with 2 inlets for VOW190	102 / 102	44	23
VOR190R2	Extra ring with 2 inlets for VOR190			23
VOW240R2	Extra ring with 2 inlets for VOW240			32
VOR240R2	Extra ring with 2 inlets for VOR240			32
VOW190R3	Extra ring with 3 inlets for VOW190	102 / 102 / 102	66	30
VOR190R3	Extra ring with 3 inlets for VOR190			30
VOW240R3	Extra ring with 3 inlets for VOW240			42
VOR240R3	Extra ring with 3 inlets for VOR240			42



Example of  
VOR240 + 3x VOR240R1



Example of  
VOW190 + VOW190M + VOW190R3



## PILLAR SYSTEM STANDARD

Stand-alone pillar system for piping support. Perfect when there is no roof or wall available. It is a cost-effective modern solution for stand alone systems.

Standard delivered:

- ▶ incl. anchors set M16 and fasteners
- ▶ excl. the piping, hoses en hose holders (separately available)



ART. NO.	Dimensions, LxH, cm	Weight, kg	Material/finish/color
PHS033	300x300	96	Steel, zinc coated + epoxy spray painted in ERGOX ECL001 or ECL002*

\*Other colors are possible on request.



## PILLAR SYSTEM CURVED

Stand-alone pillar system for piping support. Trendy and modern design system with the possibility of using sunroofs.

Standard delivered:

- ▶ incl. anchors set M20 and fasteners
- ▶ excl. the piping, hoses, hose holders and sunroofs (separately available)

ART. NO.	Dimensions, LxH, cm	Weight, kg	Material/finish/color
PHS450	425x450	240	Steel, zinc coated + epoxy spray painted in ERGOX ECL001 or ECL002*

\*Other colors are possible on request.





Sunroofs are recommended to use in combination with CURVED pillars. This combination is an eye-catcher of the modern car wash.

Sunroofs are made of strong but light material that stops up to 70% of sun light.

Available in standard size (distance between the pillars should be 400cm) and in 2 colors.

Standard delivered incl. elastic cord fixators.

	ART. NO.	Color	Material	Weight, kg	Dimensions, BxL, cm
	SUN00B	blue	PVC mesh 280g	5	380x420
	SUN00R	red			



## PILLAR SYSTEM in T-FORM

Stand-alone pillar system for piping support. Perfect when the cars can be parked on both sides of the pillars row.

Standard delivered:

- ▶ incl. anchors set M16 and fasteners
- ▶ excl. the piping, hoses en hose holders (separately available)



ART. NO.	Dimensions, LxH, cm	Weight, kg	Material/finish/color
PHS600	600x300	151	Steel, zinc coated + epoxy spray painted in ERGOX ECL001 or ECL002*

\*Other colors are possible on request.





## RAILING PIPE FOR PILLAR SYSTEMS

Strong thick-walled pipe that can be used as a decorative parapet railing between the pillars (type *standard*, *curved*, *T-form*). Two of the railing pipes are normally installed between each two pillars on two different heights from the ground.

Often installed in places where the passage of people between the pillars needs to be prevented.

In case of using *payment system with coin extraction* (see page 32 for more information), the same railing pipe (the upper pipe from two) can be used for coin transport to the central safe box, so no additional piping needs to be foreseen for this purpose.

ART. NO.	Diameter, mm	Wall thickness, mm	Length, cm	Weight, kg	Material/finish/color
PPZ051	51	3,5	400	18,5	Steel, zinc coated + epoxy spray painted in ERGOX ECL001*



*\*Other colors are possible on request.*



## Suspension Piping Supports

### PIPE AND CABLE TRAY SUPPORT SYSTEM

Support system to use indoor in case of roof/ceiling mounting.  
Calculated per meter on base of the drawing of the location.

Standard delivered:

- ▶ incl. tray couplers and fasteners
- ▶ excl. tray support brackets



ART. NO.	Description	Tray size, BxHxL, cm	Material / finish / color
CAT300	Pipe/cable tray, incl. couplers and fasteners	30x6x300	Steel, zinc coated
CAT300E			Steel, zinc coated + epoxy spray painted in ERGOX ECL001 or ECL002*

For correct suspension of pipe/cable trays on ceiling/roof it is advised to use the tray support brackets on each 2-2,5m of tray support line. The brackets are separately available:



ART. NO.	Description	Material / finish / color
CAT300CB	Cable tray support bracket for ceiling mounting, incl. fasteners and threaded rods	Steel, zinc coated
CAT300ECB		Steel, zinc coated + epoxy spray painted in ERGOX ECL001 or ECL002*

\*Other colors are possible on request.



## Suspension Piping Supports

### SUSPENSION CONSTRUCTION FOR WALL MOUNTING

Support system for piping and cables to use indoor in case of wall mounting.  
Calculated per meter and produced on base of the drawing of the location.

Standard delivered:

- ▶ incl. couplers, fasteners and suspension cables

ART. NO.	Material / finish / color
SCW000	Steel, epoxy spray painted / powder coated in ERGOX ECL001 or ECL002*

*\*Other colors are possible on request.*

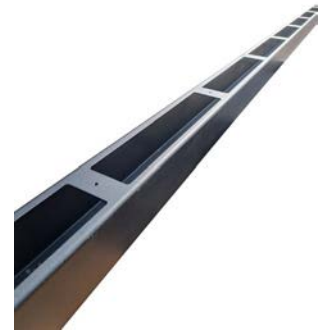



# PIPE SUPPORTS and PILLARS

## PARAPET

Support system for vacuum tool holders and other accessories (carpet clamps, waste bins, etc...). Calculated per meter and produced on base of the drawing of the location.

Standard delivered:

- ▶ incl. fasteners and brackets for wall-mount (one set for each 4-6m, depending on construction drawing of the location)



ART. NO.	Dimensions, mm	Application	Material / finish / color
RAR150	150x50x3 L= custom made	indoor	Steel + epoxy spray painted in ERGOX ECL001 or ECL002*
PAR150Z		indoor/outdoor	Steel + zinc coated + epoxy spray painted in ERGOX ECL001 or ECL002*
PAR150S		indoor/outdoor	Stainless steel AISI 304

The bracket, standard supplied with parapet, is used for connecting the parts of parapet together in one line AND for attaching the parapet to existing wall or to the parapet leg (see below).

If there is no possibility to mount the parapet on existing wall/structure, it can be also installed as a stand-alone construction. In this case a PARAPET LEG FOR FLOOR MOUNT should be foreseen each 4-6m of parapet line:

ART. NO.	Dimensions, mm	Application	Material / finish / color
RAR150L	150x50x3 H=1050	indoor	Steel + epoxy spray painted in ERGOX ECL001 or ECL002*
PAR150ZL		indoor/outdoor	Steel + zinc coated + epoxy spray painted in ERGOX ECL001 or ECL002*
PAR150SL		indoor/outdoor	Stainless steel AISI 304



*\*Other colors are possible on request.*

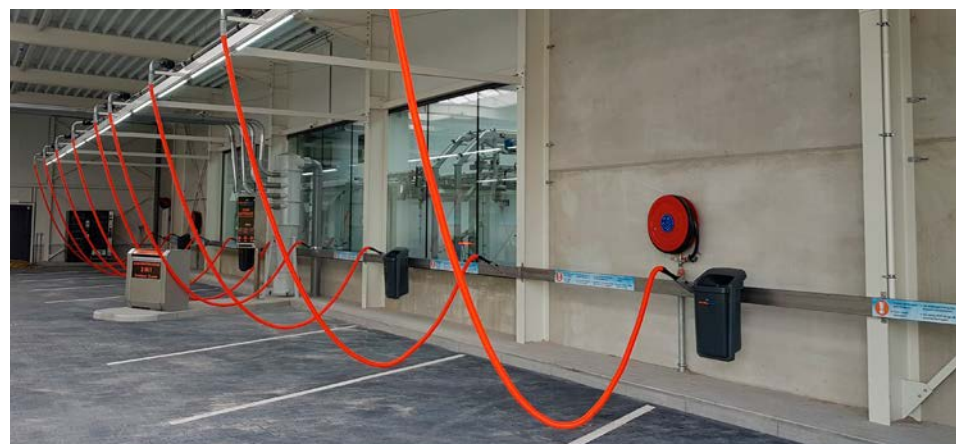

## UNIVERSAL ERGOX PILLAR

Stand-alone compact pillar that can be used for mounting ERGOX car wash accessories and holders (all separately available):

- ▶ tool holder (see page 28)
- ▶ air gun holder (see page 29)
- ▶ waste bin (see page 54)
- ▶ carpet clamp (see page 54)
- ▶ tire pump (see page 53)
- ▶ Ergox GO!

Standard delivered:

- ▶ excl. holders, accessories and fasteners

ART. NO.	Material / finish / color	Dimensions, cm	Weight, kg
CNS101	Steel, powder coated in RAL9005*	12x12 (profile) 24x24 (base plate) H= 130	14



Prefab fundament can be also separately supplied if necessary:

ART. NO.	Description
FND101	Fundament for CNS101 with cable management (optional)

*\*Other colors are possible on request.*

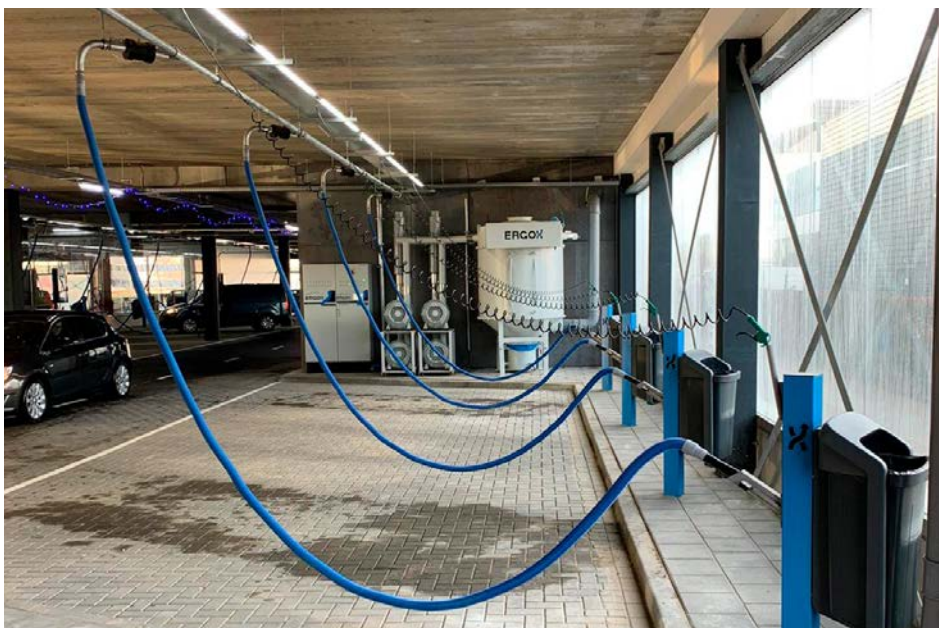



## MULTIBOX

Modern stand-alone all-in-one box with all accessories within reach.

Small opening for waste container prevents the customer from leaving large garbage behind. Powder coating in RAL color of choice makes it an eye-catcher of the modern car wash.

Standard delivered **inclusive**:

- ▶ build-in crevice tool holder (single or double)
- ▶ build-in air gun holder
- ▶ waste bin 40L
- ▶ carpet clamp

Standard delivered **exclusive**:

- ▶ crevice tool and air pressure gun (separately available, see pages 51-52)



ART. NO.	Description	Material / finish / color	Dimensions, BxDxH, cm	Weight, kg
MLT001	Multibox with single crevice tool holder	Steel, powder coated in RAL color of choice	43x74x107	75
MLT002	Multibox with double crevice tool holder	Steel, powder coated in RAL color of choice	43x74x107	75



# VACUUM VALVES

---

## VACUUM VALVE

Valve to shut off vacuum hoses. The valves are air operated and controlled by the main control board. The valve works without noise and is resistant for passing materials. Operates perfectly in any weather conditions.

ART. NO.	Diameter connection, mm	Pressure, bar	Weight, kg	Dimensions, cm
VAL050	50	2-3	2,8	27x13x13





# TOOL HOLDERS



## VACUUM TOOL HOLDER

Tool holder equipped with a sensor that detects which hose is in use. A security check allows to close the valve after set time (default 8 min) of continuous use, to prevent the accessory not being returned back into the tool holder and limit reasonable service time. Suited for Ergox crevice or claw tools (separately available, see page 51).

Standard delivered:

▶ incl. IR sensor



	ART. NO.	Description	Material / finish / color	Voltage	Dimensions, BxDxH, cm	Weight, kg
	HOH001	Crevice tool holder	Stainless steel + epoxy spray painted in ERGOX ECL001	24VDC	29x13x10	1,2
	HOH002	Claw tool holder	Stainless steel + epoxy spray painted in ERGOX ECL001	24VDC	12x15x8	0,45



## DOUBLE HOLDER ADAPTER

Adapter plate that allows to mount two crevice tool holders (HOH001) on one pillar (for systems with double hose use). Adapter fits perfectly on ERGOX pillars type *standard*, *curved*, *T-form* and *universal*.





ART. NO.	Material / finish / color	Dimensions, BxDxH, cm	Weight, kg
HOH001AD	Stainless steel + epoxy spray painted in ERGOX ECL001	33x3x14	1,45

# TOOL HOLDERS

## AIR GUN HOLDER

Available in 2 designs and suited for the Ergox air pressure gun (separately available, see page 52).

	ART. NO.	Material / finish / color	Dimensions, BxDxH, mm	Weight, kg
	AGH001	Stainless steel + epoxy spray painted in ERGOX ECL001	50x40x110	0,05
	AGH002	Stainless steel + epoxy spray painted in ERGOX ECL001	65x35x305	0,43



## ADAPTER FOR AIR GUN HOLDER

Adapter for mounting of AGH002 air gun holder on ERGOX parapet (see page 24).

ART. NO.	Material / finish / color	Dimensions, BxDxH, mm	Weight, kg
AGH002AD	Stainless steel + epoxy spray painted in ERGOX ECL001	40x40x300	0,81



## COIN ACCEPTOR SET

Pre-assembled pre-programmed set, consisting of:

- ▶ RM5 Tropicalized Electronic Coin Acceptor
- ▶ Protection cover
- ▶ Mounting plate, incl. fasteners



The set fits perfectly in the opening that is standard foreseen on Ergox Pillar Systems (type Standard/Curved/T-Form, see pages 18-20) or Ergox Coin Box (see page 31)



ART. NO.	Voltage, VDC	Dimensions, HxBxD, mm	Weight, kg
<b>CON100</b>	24	270x110x125	0,84

Build-in RM5 Tropicalized Electronic Coin Acceptor by Comestero is an advanced and reliable payment device for tokens and coins.

This model accepts up to 3 coins per second. It can be programmed for 59 different types of coins with diameter within the range 16-31,5mm, and max. to 3,3mm thick. Special CLONING system allows trouble-free and quick copying settings between different devices of the same type. Included security system protects money from mechanical and electrical interception.

- ▶ Coins accepted: Ø 16~31.5 mm, thickness up to 3.3 mm
- ▶ Channels: up to 59, each of them can be redirected to the outlets
- ▶ Standards: EN 61000-6-3, EN 61000-6-1, EN 55022
- ▶ Operating temperature: 0 – 55 °C
- ▶ Humidity: up to 75 %
- ▶ Power supply: 24 VDC

RM5 Tropicalized Electronic Coin Acceptor, as well as other components of the set, can be ordered separately:

	ART. NO.	Description	Material / finish / color	Voltage	Dimensions, HxBxD, cm	Weight, kg
	<b>COM024</b>	RM5 Tropicalized Electronic Coin Acceptor	-	24VDC	102x52x89	0,18
	<b>CON101</b>	Transparent protection cover for coin acceptor, incl. hinges	Polycarbonate	-	180x70x30	0,09
	<b>CON102</b>	Coin Acceptor Mounting Plate, incl. fasteners	Stainless steel + epoxy spray painted in ERGOX ECL001	-	270x110x2	0,50

## COIN BOX

Metal box with integrated *Coin Acceptor Set* (see page 30) with or without integrated crevice tool holder. Perfect solution for the cases when each vacuum bay needs to be equipped with its own payment unit and there are no Ergox pillars installed. Coin Box can be mounted on existing wall/construction/pillar.

In most cases Coin Box is being used in combination with Coin Extraction System that transports all the coins/tokens that get into the coin boxes, automatically to the central, safely located Coin Extraction Box (see page 33).

There are also variants available that can be used as independent payment boxes, without connection to the Coin Extraction System. In this case the coins/tokens that get into the coin box, will stay in specially foreseen removable tray that is situated inside of coin box and can be emptied manually after opening a door on the side panel of Coin Box (key lock)

				
	CNB101	CNB102	CNB201	CNB202
With integrated crevice tool holder	✓	✓	–	–
Prepared for connecting to coin extraction system	✓	–	✓	–
Foreseen with removable tray with lock	–	✓	–	✓
Material / finish / color	stainless steel, epoxy spray painted in ERGOX ECL001			
Dimensions, BxDxH, cm	23x37x56,5	13x37x56,5	23x17x56,5	13x17x56,6



## COIN EXTRACTION SYSTEM

Advanced and fully automatic system that transports the inserted coins/tokens to safely located Coin Extraction Box.

- ▶ vandalism and theft proof
- ▶ time saving (no emptying separate payment boxes: all coins/tokens arrive automatically to one central extraction box)

The coins/tokens inserted into the coin acceptor, fall into the extraction piping. When the extraction process is started up by control board, the coins/tokens get transported by vacuum along the extraction piping into the central Extraction Box, that is safely located and can be emptied manually.

Further information upon request.

### COIN EXTRACTION BOX

The box where all coins/tokens arrive after vacuum transport from all extraction lines.  
The box can be emptied manually (drawer with key lock).

ART. NO.	Q-ty of extraction lines	Dimensions, BxDxH, cm	Weight, kg
CES001	1	50x38x68	30
CES002	2		38,4
CES003	3		41,2
CES004	4		44



## CENTRALISED PAYMENT TERMINAL

Custom-made centralised terminal with integrated coin acceptor and/or other cashless payment device where all the payments can be done for all the vacuum bays. The number of push buttons on terminal is corresponding the number of vacuum bays. The push button of the paid place number will light up, so the next customer cannot choose the same number.

Centralised payment terminals are mainly for small to middle size car wash vacuum systems.

There are two variants available:

### 1. BUILT-IN Centralised Payment Terminal

This variant is mostly used to build into the existing wall of technical room of the car wash. On the backside of terminal (inside of technical room) the coin tray is located that can be manually emptied after opening the key lock on it.



ART. NO.	Description	Dimensions, BxDxH, cm	Material
CPT00xx*	with integrated COIN ACCEPTOR	50x34x92,5	Stainless steel
CPT01xx*	with integrated PAYTER (cashless payment)		
CPT02xx*	with integrated COIN ACCEPTOR and PAYTER		

### 2. STAND-ALONE Centralised Payment Terminal

Free standing payment terminal that can be installed at chosen central place.

- ▶ Standard variant needs to be emptied manually: the coin tray inside of terminal can be taken out after opening the door on the backside of terminal (key lock).
- ▶ The second variant is foreseen with connection for Coin Extraction System (see page 32). This connection is on the bottom plate of terminal and stays invisible from outside. For extraction piping in this case the PE pipe is being used. This piping is installed under ground and connects the payment terminal with Coin Extraction Box (see page 33) located in safe place



ART. NO.	Description	Dimensions, BxDxH, cm	Material
CPK0Mxx*	for manual emptying	70x66x195	Body: steel, powdercoated in RAL9005 Payment panel: stainless steel
CPK0Exx*	with integrated COIN ACCEPTOR with connection to coin extraction system		
CPK11xx*	with integrated PAYTER		
CPK2Mxx*	for manual emptying		
CPK2Exx*	with integrated COIN ACCEPTOR and PAYTER with connection to coin extraction system		

\*When ordering, the last two numbers of ART. NO (instead of xx) are to be changed into the q-ty of push buttons. Example: the stand-alone payment terminal with coin acceptor and Payter for 9 hoses/vacuum bays and connection to coin extraction system has an ART. NO CPK2E09

## ERGOX TOKEN

Brass token to use in combination with all Ergox payment systems.

Standard delivered with ERGOX-logo and text "Central vacuum system" on it:



ART. NO.	Dimensions	Weight, g	Material / color
TKN100	dia 23mm x 2mm	6	brass / silver grey

There is also an option to customize tokens with a car wash logo.  
More information upon request.

*Minimum order quantity (MOQ) of Ergox token TKN100: 500pc*  
*MOQ of Customised token TKN100LOG: 2000pc*



# PIPING

## PIPE



ART. NO.	Diameter, mm	Thickness, mm	Material / finish / color*	Pipe length, mm	Pipe weight, kg
PPZ050	50	1,5	Steel, zinc coated (hot dipped)	6000	10,8
PPZ063	63	1,5			13
PPZ076	76	1,5			16
PPZ089	89	1,5			18,6
PPZ102	102	2,0			29,5
PPZ114	114	2,0			32,5
PPZ127	127	2,0			36,5
PPZ152	152	2,0			44
PPZ200	200	1,5			44





## REDUCTION



ART. NO.	Diameter, mm	Thickness, mm	Material / finish / color*	Length, mm	Weight, kg
PRZ063050	63-50	1,5	Steel, zinc coated (hot dipped)	200	0,47
PRZ076050	76-50	1,5		200	0,52
PRZ076063	76-63	1,5		200	0,53
PRZ089076	89-76	1,5		200	0,67
PRZ102076	102-76	1,5		200	0,87
PRZ102089	102-89	2,0		200	0,89
PRZ114102	114-102	2,0		200	1,15
PRZ127102	127-102	2,0		200	1,35
PRZ127114	127-114	2,0	Steel, powder coated in RAL7035	200	1,42
PRZ152127	152-127	2,0		200	1,63

\*Other colors are possible on request.

## BEND

	ART. NO.	Diameter, mm	Thickness, mm	Material / finish / color*	Weight, kg
<b>BEND 15° R=2,5D</b>					
	PBZ15050	50	1,5	Steel, zinc coated (hot dipped)	0,46
<b>BEND 22,5° R=2,5D</b>					
	PBZ22050	50	1,5	Steel, zinc coated (hot dipped)	0,50
	PBZ22063	63	1,5		0,63
	PBZ22076	76	1,5		0,76
	PBZ22089	89	1,5		0,89
	PBZ22102	102	2		1,00
	PBZ22114	114	2		1,14
<b>BEND 45° R=2,5D</b>					
	PBZ45050	50	1,5	Steel, zinc coated (hot dipped)	0,57
	PBZ45063	63	1,5		0,70
	PBZ45076	76	1,5		0,89
	PBZ45089	89	1,5		1,20
	PBZ45102	102	2		1,78
	PBZ45114	114	2		2,50
<b>BEND 90° R=2,5D</b>					
	PBZ90050	50	1,5	Steel, zinc coated (hot dipped)	0,80
	PBZ90063	63	1,5		1,10
	PBZ90076	76	1,5		1,26
	PBZ90089	89	1,5		1,50
	PBZ90102	102	2		2,40
	PBZ90114	114	2		3,10
<b>BEND 105° R=2,5D</b>					
	PBZ10550	50	1,5	Steel, zinc coated (hot dipped)	0,84



\*Other colors are possible on request.

## SEGMENTED BEND



	ART. NO.	Diameter, mm	Thickness, mm	Material / finish / color*	Weight, kg
<b>SEGMENTED BEND 45°</b>					
	PBS45127	127	2,00	Steel, powder coated in RAL7035	5,2
	PBS45152	152			5,8
	PBS45200	200			6,4
	PBS45250	250			7
<b>SEGMENTED BEND 90°</b>					
	PBS90127	127	2,00	Steel, powder coated in RAL7035	5,5
	PBS90152	152			6
	PBS90200	200			6,8
	PBS90250	250			7,4
<b>SEGMENTED S-BEND</b>					
	PBSS127	127	2,00	Steel, powder coated in RAL7035	5,4

## TROUSER



ART. NO.	Diameter, mm	Thickness, mm	Material / finish / color*	Weight, kg
PTZ050	50-50-50	1,5	Steel, zinc coated (hot dipped)	0,9
PTZ063	63-63-63	1,5		1,13
PTZ076	76-76-76	1,5		1,6
PTZ089	89-89-89	1,5		1,87
PTZ102	102-102-102	2,0		2,15

\*Other colors are possible on request.

## BRANCH

	ART. NO.	Diameter, mm	Thickness, mm	Material / finish / color*	Weight, kg
<b>BRANCH 45° L=300mm</b>					
	PBR455050	50-50-50	2,00	Steel, zinc coated (hot dipped)	0,96
	PBR456350	63-50-63			0,96
	PBR457650	76-50-76			1,00
	PBR458950	89-50-89			1,20
	PBR4510250	102-50-102			1,20
	PBR4511450	114-50-114			1,34
	PBR4512750	127-50-127			1,50
	PBR4515250	152-50-152			1,78
	PBR456363	63-63-63			1,00
	PBR457676	76-76-76			1,10
	PBR458989	89-89-89			1,25
	PBR458976	89-76-89			1,20
	PBR458963	89-63-89			1,23
	PBR45102102	102-102-102			1,30
	PBR4510289	102-89-102			1,25
	PBR4510276	102-76-102			1,20
	PBR4510263	102-63-102			1,15
	PBR45114114	114-114-114			2,80
	PBR45127127	127-127-127			3,10
PBR45152152	152-152-152	3,65			
<b>LONG BRANCH 45° L=4000mm</b>					
	PBR455050L	50-50-50	2,00	Steel, zinc coated (hot dipped)	9,50
	PBR456350L	63-50-63			12,20
	PBR457650L	76-50-76			14,50
	PBR458950L	89-50-89			16,70
	PBR4510250L	102-50-102			19,75



\*Other colors are possible on request.



# PIPING

---

## END CAP/STOP

ART. NO.	Diameter, mm	Thickness, mm	Material / finish / color*
END050	50	2	Stainless steel AISI 304
END063	63		
END076	76		
END089	89		
END102	102		
END114	114		
END127	127		
END152	152		
END200	200		
END250	250		

*\*Other colors are possible on request.*

## PIPE COUPLING

ART. NO.	Diameter, mm	Length, mm	Material / finish / color*	Weight, g
PCO050	50	100	Stainless steel outside body AISI304 with black synthetic rubber gasket inside	295
PCO063	63	100		315
PCO076	76	100		370
PCO089	89	150		635
PCO102	102	150		700
PCO114	114	150		740
PCO127	127	150		775
PCO152	152	150		815
PCO200	202	150		1090
PCO250	250	150		1365

\*Other colors are possible on request.



## PIPE BRACKET

ART. NO.	Diameter, mm	Thread	Material / finish / color
PBC050	50	M8	Galvanised steel with EPDM sealing ring
PBC063	63	M8	
PBC076	76	M8	
PBC089	89	M8	
PBC102	102	M8/M10	
PBC114	114	M8/M10	
PBC127	127	M8/M10	
PBC152	152	M8/M10	Galvanised steel
PBC200	200	M8/M10	
PBC250	250	M8/M10	



## LOW AIRSPEED PVC PIPING



	ART. NO.	Diameter, mm	Thickness, mm	Material / color
<b>Pipe L=5m</b>				
	PVC200	200	3,9	PVC / grey
	PVC250	250	4,9	
<b>Bend 45° FF</b>				
	PBN20045FF	200	-	PVC / grey
	PBN25045FF	250	-	
<b>Bend 45° MF</b>				
	PBN20045MF	200	-	PVC / grey
	PBN25045MF	250	-	
<b>Bend 87° FF</b>				
	PBN20087FF	200	-	PVC / grey
	PBN25087FF	250	-	
<b>Bend 87° MF</b>				
	PBN20087MF	200	-	PVC / grey
	PBN25087MF	250	-	
<b>Branch 45° FFF</b>				
	PTE20045	200-200-200	-	PVC / grey
<b>Branch 87° FFF</b>				
	PTE20087	200-200-200	-	PVC / grey
	PTE25087	250-250-250	-	
<b>Sleeve</b>				
	PCP200	200	-	PVC / grey
	PCP250	250	-	
<b>Reducer</b>				
	PRD250200	250M x 200F	-	PVC / grey

## LOW AIRSPEED METAL PIPING

	ART. NO.	Diameter, mm	Thickness, mm	Material / color
<b>Pipe L=2m</b>				
	MET150	150	0,75	sendzimir galvanized steel
	MET200	200		
	MET250	250		
<b>Bend 45°</b>				
	MBN15045	150	-	sendzimir galvanized steel
	MBN20045	200	-	
	MBN25045	250	-	
<b>Bend 90°</b>				
	MBN15090	150	-	sendzimir galvanized steel
	MBN20090	200	-	
	MBN25090	250	-	
<b>Branch 90°</b>				
	MTE20090	200	0,88	sendzimir galvanized steel
	MTE25090	250	0,88	
<b>Reducer</b>				
	MRD250200	250 x 200	0,88	sendzimir galvanized steel
<b>Tension ring (incl. 2x bolt M5)</b>				
	MTR150	150	-	sendzimir galvanized steel
	MTR200	200	-	
	MTR250	250	-	
<b>Welding end L=55mm</b>				
	MWE150	150	2	steel
	MWE200	200	2	
	MWE250	250	2	



## STRAIGHT CONNECTOR

### *PUSH-IN x THREAD*



PUSH-IN x MALE THREAD		
ART. NO.	Diameter, mm	Thread size
PSM614	6	1/4"
PSM612		1/2"
PSM814	8	1/4"
PSM812		1/2"
PSM1014	10	1/4"
PSM1212	12	1/2"
PSM1612	16	1/2"

PUSH-IN x FEMALE THREAD		
ART. NO.	Diameter, mm	Thread size
PSF614	6	1/4"
		1/2"
PSF814	8	1/4"
		1/2"
PSF1014	10	1/4"

## BEND 90° FITTING

### *PUSH-IN x THREAD*



ART. NO.	Diameter, mm	Thread size	Thread type
PFB0614	6	1/4"	Male
PFB0814	8		
PFB1014	10		



## STRAIGHT CONNECTOR

*PUSH-IN x PUSH-IN*

ART. NO.	Diameter, mm
PCN006	6 - 6
PCN008	8 - 8
PCN010	10 - 10
PCN012	12 - 12
PCN016	16 - 16



## STRAIGHT REDUCER

*PUSH-IN x PUSH-IN*

ART. NO.	Diameter, mm
PCN0604	6 - 4
PCN0806	8 - 6
PCN1008	10 - 8
PCN1210	12 - 10
PCN1412	14 - 12
PCN1614	16 - 14



## 5-WAY UNION CONNECTOR

*PUSH-IN*

ART. NO.	Diameter, mm
PCL006	5 x 6
PCL008	5 x 8



## T UNION CONNECTOR

### *PUSH-IN*



ART. NO.	Diameter, mm
PTT006	6 - 6 - 6
PTT008	8 - 8 - 8
PTT010	10 - 10 - 10
PTT012	12 - 12 - 12
PTT016	16 - 16 - 16
PTT080608	8 - 6 - 8
PTT100810	10 - 8 - 10

## Y UNION CONNECTOR

### *PUSH-IN*



ART. NO.	Diameter, mm
PYY006	6 - 6 - 6
PYY008	8 - 8 - 8
PYY010	10 - 10 - 10
PYY012	12 - 12 - 12
PYY016	16 - 16 - 16

## TRANSIT FITTING



PUSH-IN x PUSH-IN	
ART. NO.	Diameter, mm
PTR006	6 - 6
PTR008	8 - 8
PTR010	10 - 10
PTR012	12 - 12



PUSH-IN x THREAD			
ART. NO.	Diameter, mm	Thread size	Thread type
PTR0614	6	1/4"	Female
PTR0814	8	1/4"	Female



## PU HOSE

ART. NO.	Outer diameter, mm	Inner diameter, mm	Roll length, m
PHO006	6	4	400
PHO008	8	5	250
PHO010	10	6,5	100
PHO012	12	8	100
PHO016	16	12	100



# PE HOSE & COMPRESSION FITTINGS

## PE HOSE



ART. NO.	Diameter, mm	Wall thickness, mm	Roll length, m
PEH016	16	1,8	100
PEH020	20	2,2	
PEH025	25	2,0	
PEH063	63	5,8	

## STRAIGHT COMPRESSION CONNECTOR



ART. NO.	Diameter, mm
PES2020	20 - 20
PES2525	25 - 25

## STRAIGHT THREADED COMPRESSION CONNECTOR



MALE THREAD		
ART. NO.	Diameter, mm	Thread size
PEC1612M	16	1/2"
PEC2012M	20	1/2"
PEC2534M	25	3/4"



FEMALE THREAD		
ART. NO.	Diameter, mm	Thread size
PEC1612F	16	1/2"
PEC2012F	20	1/2"

## BEND 90° COMPRESSION FITTING

ART. NO.	Diameter, mm
PEB016	16
PEB020	20
PEB025	25



## T 90° COMPRESSION FITTING WITH FEMALE THREAD

ART. NO.	Sizes (diameter – thread – diameter)
PET201220	20mm – 1/2" F – 20mm



## UNION BALL VALVE

ART. NO.	Thread size/type	Material
BLV012MF	1/2" M - 1/2" F	brass





## VACUUM HOSE



						
<b>ART. NO.</b>	HOS038BG	HOS038YB	HOS038OB	HOS038RB	HOS038GB	HOS038BB
<b>Color (outside ring / inside ring)</b>	blue/grey	yellow/black	orange/black	red/black	green/black	black/black
<b>Inner diameter, mm</b>	38					
<b>Outer diameter, mm</b>	50					
<b>Material</b>	EVA					
<b>Roll length, m</b>	20					
<b>Roll weight, kg</b>	6,9					

### FEATURES:

- ▶ Crush-proof, kink-resistant and durable
- ▶ Ultimate flexible and easy to handle in any weather conditions
- ▶ Colourfast and UV-resistant
- ▶ Smooth inside surface for better flow
- ▶ Easy adjustable with box cutter to achieve the desired length

# CLEANING TOOLS AND ACCESSOIRES

## VACUUM NOZZLES

			
<b>ART. NO.</b>	<b>CRB038</b>	<b>CLA038</b>	<b>CLL038</b>
<b>Description</b>	crevice tool	claw tool	claw tool LONG
<b>Material</b>	polyethylene		
<b>Color</b>	black		
<b>Outer diameter</b>	1,5" (38 mm)		
<b>Total length,cm</b>	40,5	28	58,5



## CONNECTORS AND ACCESSOIRES

					
<b>ART. NO.</b>	<b>CUG038</b>	<b>CUB038</b>	<b>HPC385</b>	<b>HPD038</b>	<b>HCC046</b>
<b>Description</b>	Swivel hose-to-nozzle connector		Non-swivel hose-to-pipe connector	Swivel hose-to-pipe connector	Hose clamp
<b>Color</b>	grey	black	grey	grey	stainless steel
<b>Connection type/size</b>	one side threaded for hose with inner diameter 38mm / another side is for tool with outer diameter 38mm		one side threaded for hose with inner diameter 38mm / another side is for pipe with outer diameter 50mm		diameter 40-60mm (to use in combination with HPC385 or HPD038 to seal/secure hose-to-pipe connection)



## AIR PRESSURE SYSTEM ACCESSOIRES



	ART. NO.	Description	Sizes	Material	Color
	GUN001	Air gun (standard)*	L=250mm	nylon / stainless steel	green/black
	GUN011	Air gun (high quality)*	L= 200mm	nylon / stainless steel	green/blue
	PSH009	Spring hose*	L=9m / outer diameter 8mm / inner diameter 5mm	PU	black
	FSH148	Compression fitting for air gun connection to spring hose	1/4M x PU 8mm	-	-
	SSH090	Spring hose support 90°, incl. PU transit fitting 8-8mm	40mm x 40mm x 40mm	stainless steel + epoxy spray painted in ECL001	ECL001

\*Spring hose PSH009 and air guns GUN001 and GUN011 are standard delivered exclusief connectors/fittings.

In some cases when the standard length of spring hose is not enough, an extension can be used between the spring hose and the 90° support:



ART. NO.	Outer diameter, mm	Inner diameter, mm	Material	Color	Roll length, m
PSE008	8	5	PU	black	100

PSE008 is delivered in full rolls and can be easily cut to desired length on the location.

For connection between the spring hose and the extension, a PU push-in connector PCN008 is advised to be used (to order separately, see page 45)

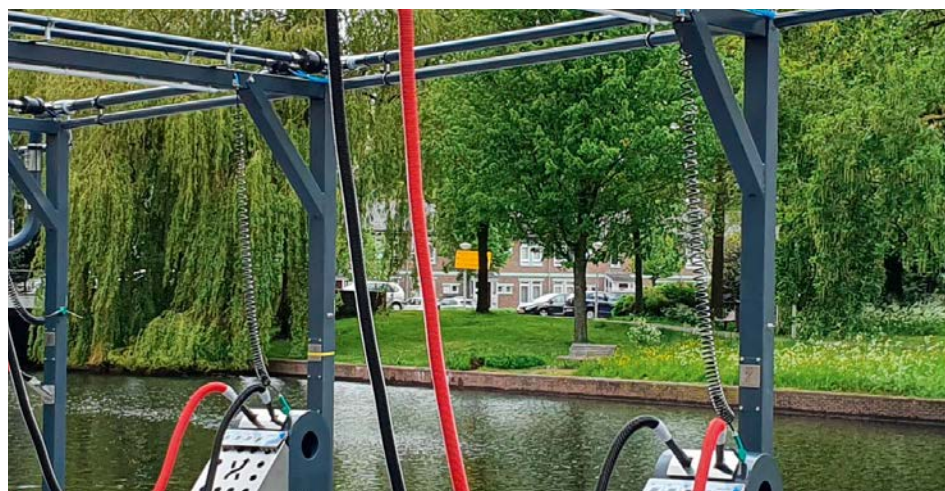

## TIRE INFLATOR

Helps to check the tire pressure and corrects it if necessary.

- ▶ Easy to use for customers
- ▶ Vandalism proof metal housing
- ▶ Adjustable with push button
- ▶ Display for communication
- ▶ Safe roll-up system with break

**WORKING:** Insert the right tire pressure with +/- buttons and read it on display. The unit starts automatically when the gauge is connected to the tire. A sound signal and blinking display let you know that the required value of air pressure is reached. Disconnect the gauge and the inflator will stop automatically.

### TECHNICAL DATA:

- ▶ Voltage 24VDC
- ▶ Hose length max. 10m
- ▶ PU hose dia 8mm
- ▶ Pressure 1-8 bar
- ▶ Standard metal gauge



ART. NO.	Voltage	Pressure, bar	Material / finish / color	Weight, kg	Dimensions, WxDxH, cm
TRP024	24VDC	1-8	Stainless steel, powder coated in RAL9005	31	30x38x101

Upon request it can be also adjusted and delivered for 230VAC/50Hz:

ART. NO.	Description
TRP230	Tire inflator adjustment: voltage 230VAC/50Hz instead of standard 24VDC

Tire inflator can be easily mounted on *UNIVERSAL ERGOX PILLAR* (art. CNS101, see page 25) for stand-alone variant.

In case of mounting on existing wall/pillar/construction, a special *WALL BRACKET* can be used:

ART. NO.	Material / finish / color	Weight, kg	Dimensions, WxDxH, cm
TRP024WB	Steel, zinc coated + powder coated in RAL9005	8,50	31x12x42



Tire inflator is standard free to use for customers. Possibilities to make it a paid service/option upon request.



## CARPET CLAMP

Sturdy and ergonomic carpet clamp/holder for convenient vacuuming of car floor carpets.

Can be easily installed on universal Ergox pillar (see page 25), parapet (see page 24), pillars Standard, Curved, T-Form (see pages 18-20) or on existing wall/construction.

Standard delivered **inclusive**:

- ▶ back plate
- ▶ fasteners
- ▶ user manual sticker



ART. NO.	Material / finish / color	Dimensions, BxDxH, cm	Weight, kg
CRP002	stainless steel (clamp) / steel, powder coated in RAL9005* (back plate)	45x34x51	10

\*Other colors are possible on request.

## WASTE BIN

Neutral grey plastic waste bin with a capacity of 50 liters for in- and outdoor use with grey holder for wall or pillar mounting. The waste bin is made of injected HDPE, is UV and weather resistant and has corrosion proof metal parts, making the bin resistant to vandalism, temperature differences and many chemicals. Smooth surfaces make emptying and maintenance easy.

A mounting bracket is attached to the waste bin holder for easy installation on the wall or pillar. For emptying, the bin can be easily removed from the holder. The bin closes/opens with a triangular lock at the top. A triangular key is included.



ART. NO.	Material	Color	Dimensions, WxDxH, cm	Content, L
WST001	HDPE	grey	46x39x84,5	50



## LED LIGHTING

LED tubes for general lighting of vacuum bays or car wash hall.

- ▶ IP65 water- and dustproof (suitable for in- and outdoor use)
- ▶ Easy to connect (connection cable glands make it simple to connect different tubes in one line)
- ▶ Easy to install (mounting clips are standard delivered with the tube)
- ▶ Durable and economical in consumption

LED tubes are standard delivered:

- ▶ incl. mounting clips
- ▶ excl. connection cable (can be ordered separately)

ART. NO.	Description	Voltage	Power	Color	Length, cm	Diameter, cm	Weight, kg
<b>LED200M</b>	LED tube, double ended	230VAC	25W	6000K (cool white)	200	3	0,7
<b>LED200E</b>	LED tube, single ended	230VAC	25W	6000K (cool white)	200	3	0,65
<b>LED200C</b>	Connection cable for LED tube	-	-	white	500	-	0,25





## SIGNAL TOWER

Makes it possible to verify the status of the vacuum system from the distance. Gives clear safety warnings and attracts attention if necessary.

- ▶ Robust and resistant to impacts housing
- ▶ Lightweight and compact design
- ▶ Bright and durable LED bulbs
- ▶ Easy to install

ART. NO.	Lens Color	Light type	Voltage	Height, mm	Diameter, mm
EST003	Red, orange, green	LED	24VDC	350	50



## SAFETY VALVE

Adjustable safety valve for protection of filter system in case of too high negative pressure. It is required to install one safety valve in each system.

ART. NO.	Material / finish / color	Length, mm	Diameter, mm	Weight, kg
SAF127	Steel, powder coated in RAL7035	300	127	2



## WALL MOUNTED OUTLET NOZZLE

ART. NO.	Diameter, mm	Material / finish	Length, mm
WNZ102	102	Steel, powder coated	600
WNZ127	127		
WNZ152	152		



## TECHNICAL CONTAINER

Insulated container made of 80mm PIR panels with metal door. Perfect as a technical room at the locations with lack of free existing space. If ordered together, all the system technics (control board, filter system, vacuum pumps) will be pre-installed before the delivery.

- ▶ Insulated (80mm PIR panels)
- ▶ Strong metal door with door pump
- ▶ Foreseen with ventilation and frost protection
- ▶ 2 electrical sockets and general lighting
- ▶ With integrated/hidden rainwater drainage



ART. NO.	Dimensions, BxLxH,* cm	Color
CNT400	240x400x278	RAL color of choice
CNT600	240x600x278	

\* Other sizes are on request.

## SPARE PARTS and COMPLEMENTARY ITEMS

ART. NO.	Description
<b>CONTROL BOARDS</b>	
FAN001	Cooling fan for electrical cabinet 24VDC dia 120mm
PSP2405	Power supply 24VDC 5A
PSP2410	Power supply 24VDC 10A
REL241	Relay 24VDC 10A
CP6606	Touchscreen PLC panel Beckhoff CP6606 incl. licentie windows CE
<b>FILTER SYSTEMS &amp; CYCLONIC PRESEPARATORS</b>	
FIL020	Cartridge filter 20m <sup>3</sup> , polyester
RBR4020	Rubber seal EPDM 40x20mm, <b>per m</b> (1 roll = 10m)
RBR3015	Rubber seal EPDM 30x15mm, <b>per m</b> (1 roll = 10m)
RBR2008	Rubber seal EPDM 20x8mm, <b>per m</b> (1 roll = 10m)
RBR2508	Rubber seal EPDM 25x8mm, <b>per m</b> (1 roll = 10m)
RBR3008	Rubber seal EPDM 30x8mm, <b>per m</b> (1 roll = 10m)
<b>PIPE SUPPORTS &amp; PILLARS</b>	
MLP001	Deposit on mould plate for pillar system STANDARD
MLP002	Deposit on mould plate for pillar system CURVED
MLP003	Deposit on mould plate for pillar system in T-FORM
MLP004	Deposit on mould plate for UNIVERSAL Ergox pillar
ANC020	Set Anchors M20 for pillar system CURVED
ANC016	Set Anchors M16 for pillar system STANDARD/T-FORM
TFS001	Elastic tensioner for sunroof
<b>INSTALLATION SUPPLIES</b>	
CAT150	Cable tray 15cm x 6cm x L300cm, zinc coated steel, incl. couplers and fasteners
CAT300	Cable tray 30cm x 6cm x L300cm, zinc coated steel, incl. couplers and fasteners
CAT300CB	Cable tray support bracket for ceiling mounting, zinc coated steel, incl. fasteners and threaded rods (suitable for CAT150 and CAT300)
CAT300WB	Cable tray support bracket for wall mounting, zinc coated steel, incl. fasteners (suitable for CAT150 and CAT300)
CAB375	Multi cable 3x0,75mm <sup>2</sup> , per m
CAB575	Multi cable 5x0,75mm <sup>2</sup> , per m
CAB1875	Multi cable 18x0,75mm <sup>2</sup> , per m
CAB2575	Multi cable 25x0,75mm <sup>2</sup> , per m
CAB34100	Multi cable 34x1mm <sup>2</sup> , per m
CAB3G15	Cable VOB3G1,5, per m
CAB3G25	Cable VOB3G2,5, per m
<b>VACUUM VALVES</b>	
RUB001	Replacement rubber for vacuum valve VAL050
<b>TOOL HOLDERS</b>	
PHO024	IR sensor for tool holder
CAP420	Tapered cap 40mmx20mm black PE
<b>CLEANING TOOLS AND ACCESSOIRES</b>	
GUN002	Replacement plastic cap for air gun GUN001
<b>CAR WASH EXTRA'S</b>	
GUN003	Nozzle for tire inflator, open type 3/8"F
RUB003	Replacement rubber for tire inflator nozzle







# ERGOX

ERGOX Ltd.  
VENLOSESTEENWEG 149  
3680 MAASEIK - BELGIUM

+32 89 244 529  
info@ergox.com

[www.ergox.com](http://www.ergox.com)

C22.05